

➤ Instructions

Thule Mounting Bracket 901882

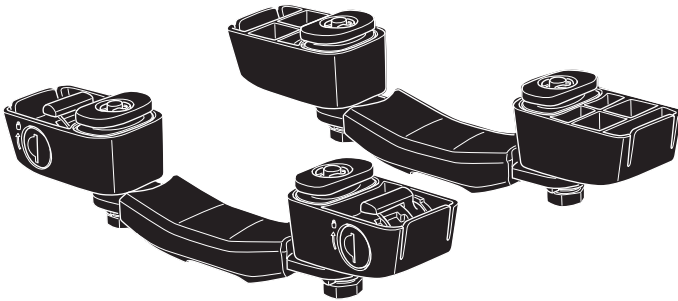

- EN** Mounting bracket for accessories on roof-mounted load carrier
- FR** Support de montage pour accessoires sur barre de toit
- ES** Soporte de montaje para accesorios de portaequipajes de techo
- DE** Halterung für Zubehör am Dachlastenträger
- NL** Montagebeugel voor accessoires voor op het dak gemonteerde dakdrager
- PT** Suporte para montagem de acessórios em racks automotivos de teto
- IT** Staffa di montaggio per accessori su portapacchi da tetto
- SV** Monteringsfäste för tillbehör på takmonterad lasthållare
- DK** Monteringsbeslag til tilbehør på tagmonteret lastholder
- NO** Monteringsbrakett for tilbehør på takmontert lastestativ
- FI** Varusteteline katolle asennettaviin kuljetuslaatikoihin
- IS** Festing fyrir aukahluti á farangursgrind á þak
- ET** Katuseraami tarvikute kinnituskamber
- LV** Stiprināšanas kronšteins piederumiem, kurus novieto uz jumta uzstādāmā turētāja
- LT** Laikiklis tvirtinti priedus prie ant stogo montuojamos bagažinės
- RU** Монтажная скоба для аксессуаров на багажник на крышу
- UK** Монтажний кронштейн для аксессуарів на багажник для даху
- PL** Wspornik mocujący do akcesoriów na bagażniku bazowym montowanym na dachu
- CS** Montážní držák pro příslušenství na montáž střešního nosiče
- HU** Rögzítőelem a tetőre szerelhető csomagszállító tartozékaihoz
- RO** Consolă de montare pentru accesorii pe suportul de transport montat pe acoperiș

- SK** Montážna konzola pre príslušenstvo na strešnom nosiči
- SL** Nosilec za dodatke na strešnem prtljažniku
- BG** Скоба за монтаж за аксесоари на товар в багажник, монтиран върху покрива
- HR** Montažni nosač za dodatnu opremu na krovnom nosaču tereta
- EL** Βραχίονας στερέωσης αξεσουάρ στη σχάρα οροφής μεταφοράς φορτίου
- TR** Araç üstüne bağlanan yük taşıyıcısı üzerindeki aksesuarlar için montaj bağlantı parçası
- MT** Brekit tal-immuntar għall-accessorji fuq il-ġarrier tat-tagħbija mmuntat fuq is-saqaf

HE AR סוגר הרכבה לאביזר ממשל הרכבה על הגג תיגייז פתרכיב המלחقات על נאقل המוולה למثبت על הסק

- ZH (CN)** 用于顶置货物托架配件的安装支架
- ZH (TR)** 安裝車頂荷重支架配件的托座
- JA** ルーフマウント型ロードキャリアのアクセサリ用マウンティングブラケット
- KO** 루프 장착형 로드 캐리어의 액세서리용 장착 브라켓
- TH** ขายึดอุปกรณ์เสริมสำหรับโครงสร้างยึดของบนหลังคา
- MS** Pendakap pemasangan untuk aksesori pada pembawa muatan yang dipasang di atas bumbung

CITY CRASH

Complies with ISO norm

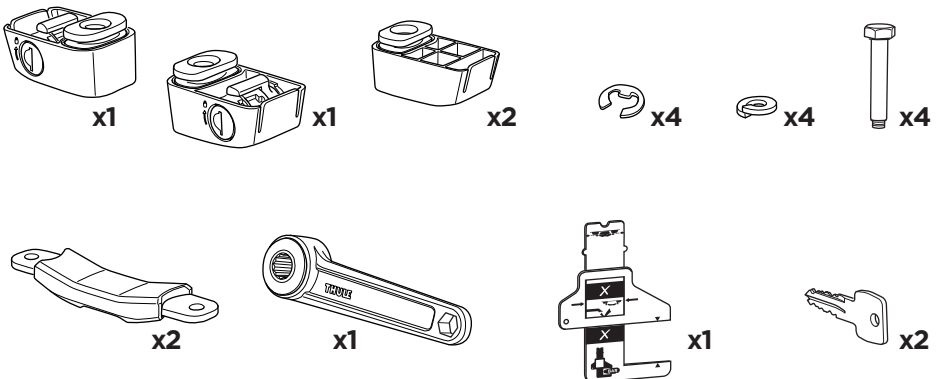
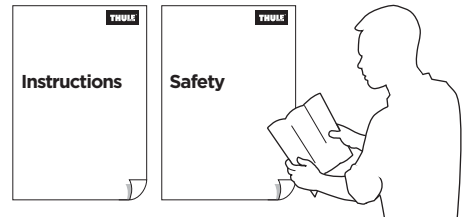

i



i

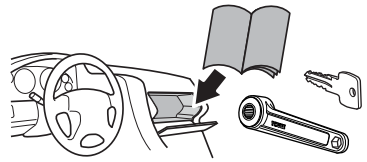

THULE
SlideBar Evo

THULE
TracRac



THULE
WingBar Evo

THULE
AeroBlade

THULE
Xsporter

THULE
ProBar Evo

THULE
SquareBar Evo

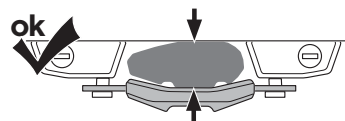
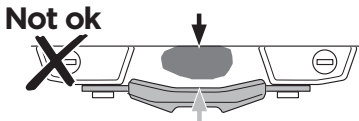
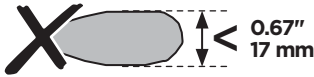
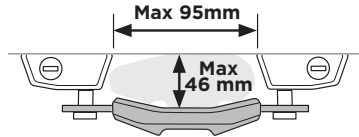
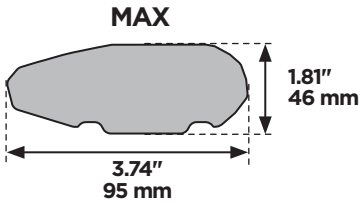
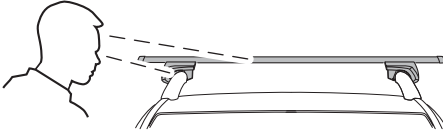

> Video Instructions
Thule Mounting Bracket



thule.com

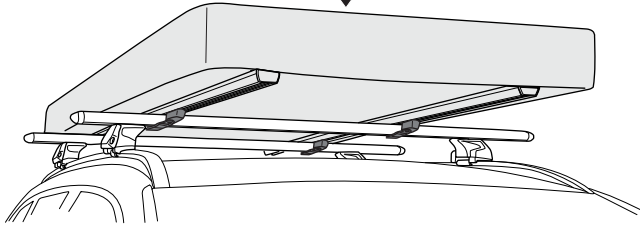

i

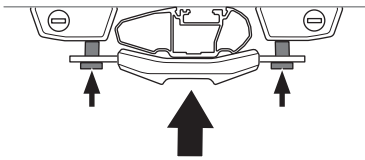

Alt I

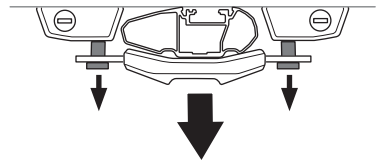
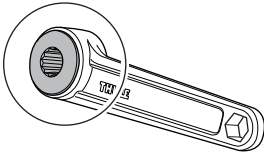

Alt II

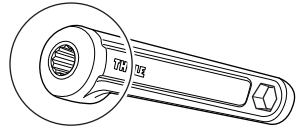

i

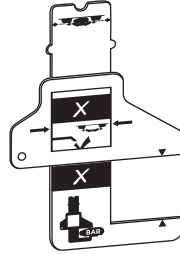
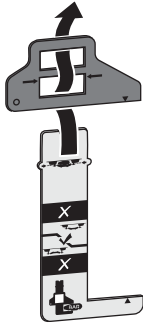

1

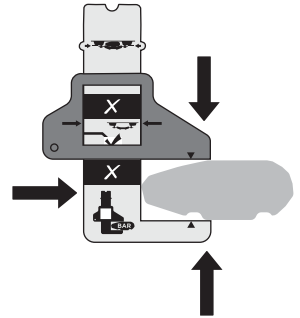
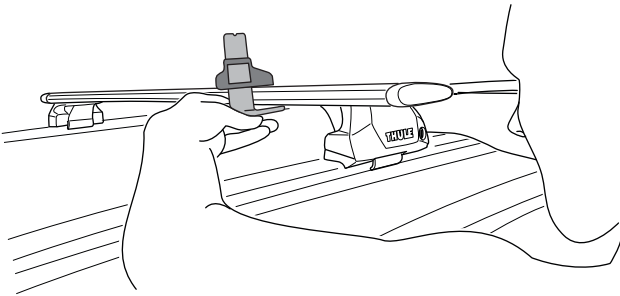

Fit ok

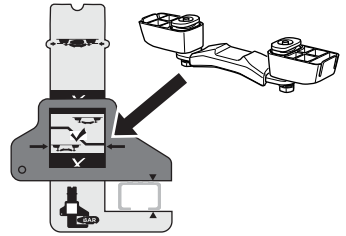
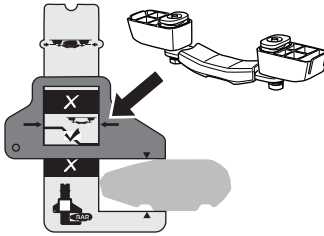

Fit Not ok

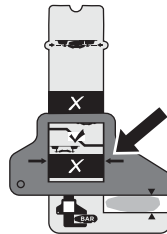
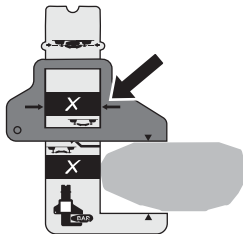

2

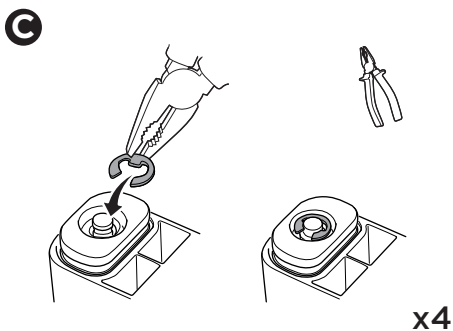
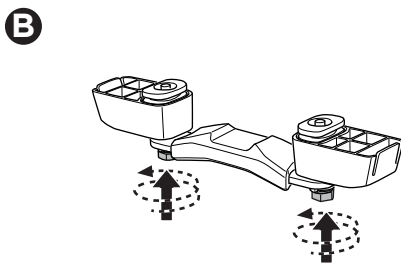
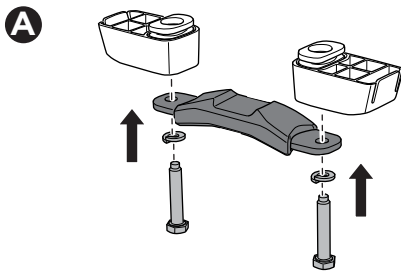
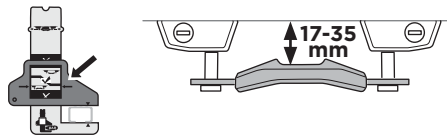
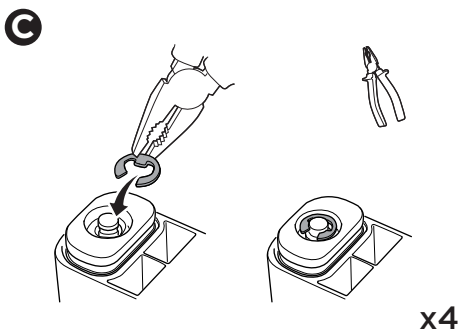
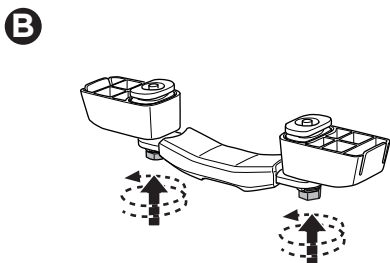
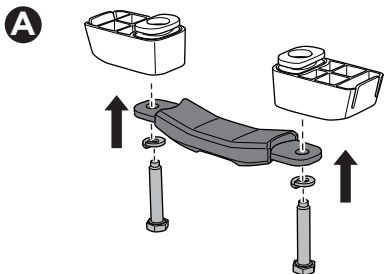
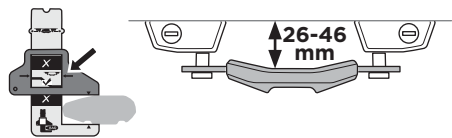

ok ✓

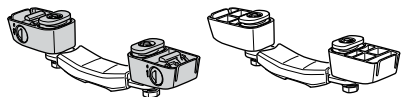

Not ok ✗

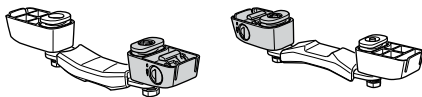

3

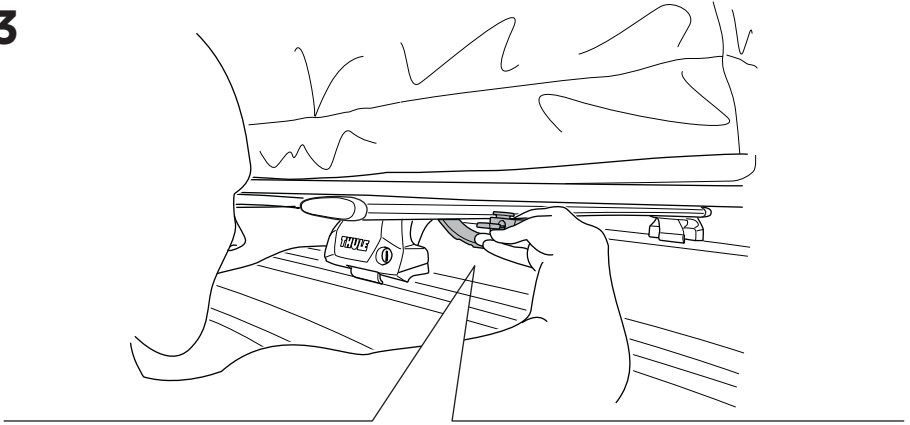

A

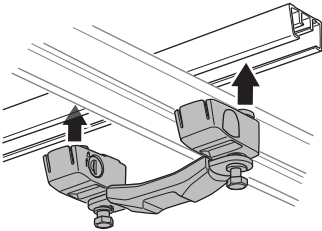

B

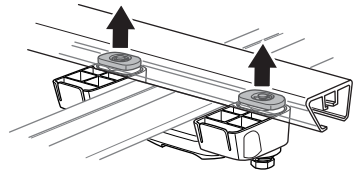

C

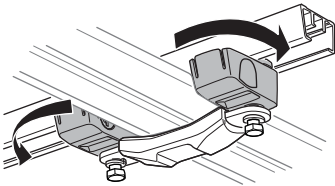

D

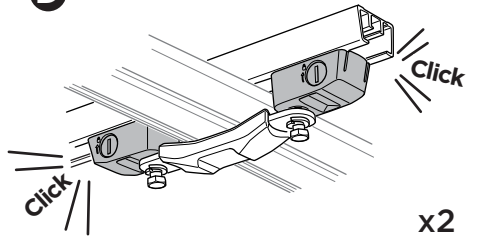

Not ok

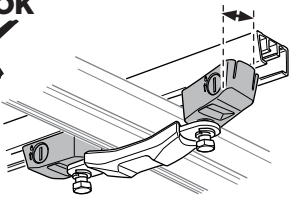

ok

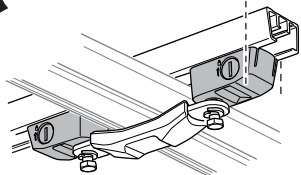

4

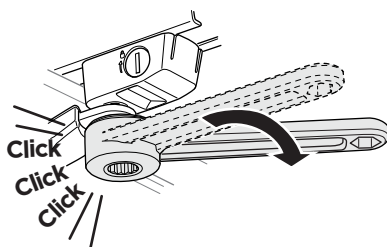
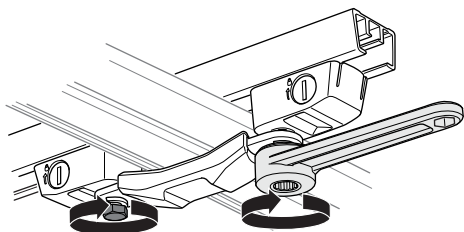
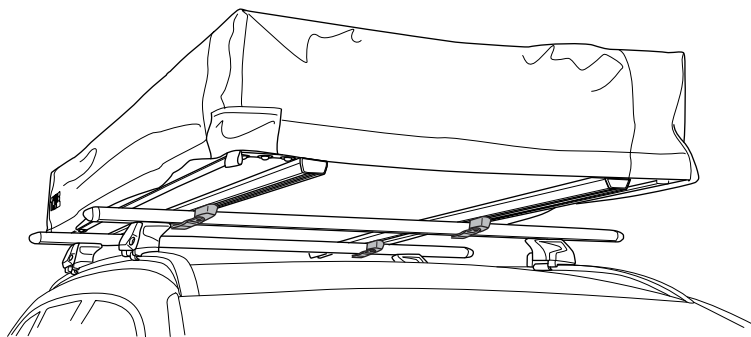

i

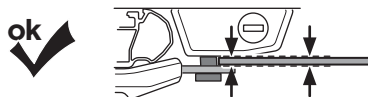
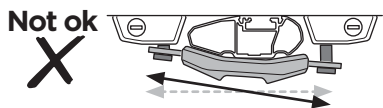
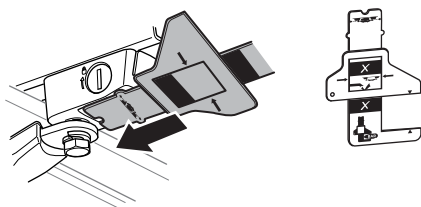
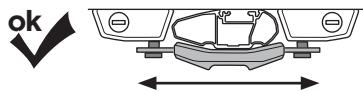

5

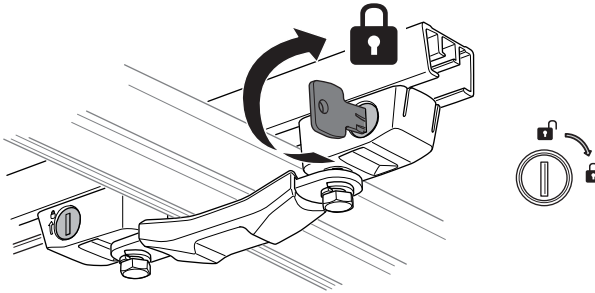

i

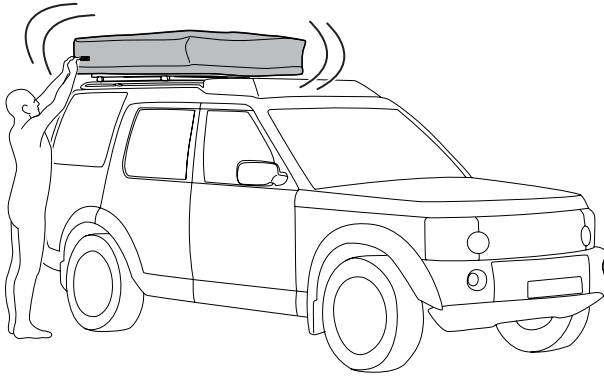

i



i

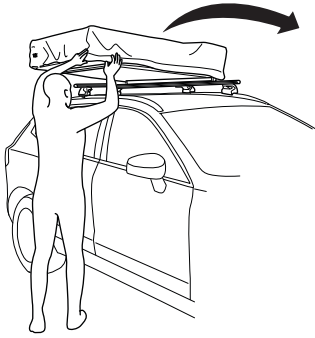

A

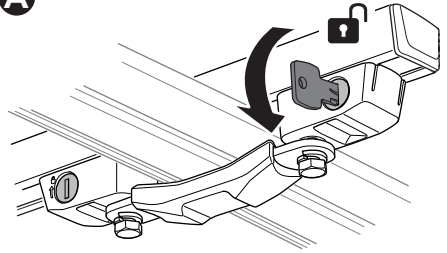

B

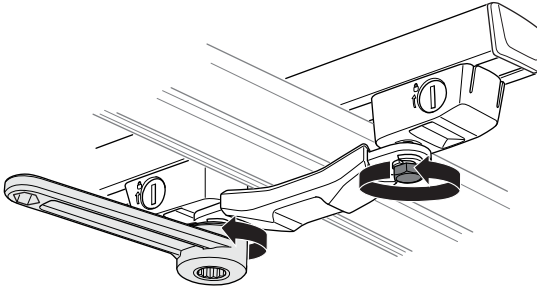

Alt II



C

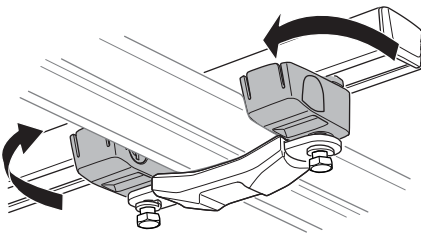

D

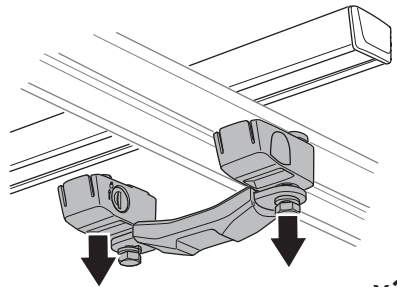

x2

EN Accessories
FR Accessoires
ES Accesorios
DE Zubehör
NL Accessoires
PT Acessórios
IT Accessori
SV Tillbehör
DK Tilbehør
NO Tilbehør
FI Lisävarusteet
IS Aukabúnaður

ET Tarvikud
LV Piederumi
LT Priedai
RU Аксессуары
UK Аксесуари
PL Akcesoria
CS Příslušenství
HU Kiegészítők
RO Accesorii
SK Príslušenstvo
SL Dodatna oprema
BG Аксесоари

HR Dodatna oprema
EL Αξεσουάρ
TR Aksesuarlar
MT Aċċessorji

HE אביזרים
AR الملحقات

ZH (CN) 附件
ZH (TR) 配件
JA アクセサリー
KO 액세서리
TH อุปกรณ์เสริม
MS Aksesori

Thule One-Key System

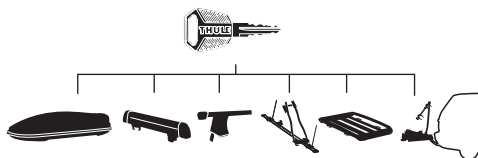

450400  (x4)

450600  (x6)

450800  (x8)

451200  (x12)

A

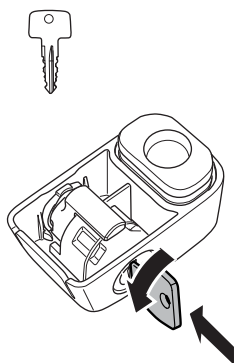

B

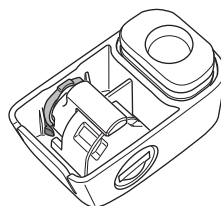

C

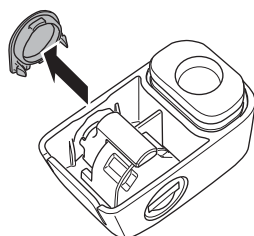

D

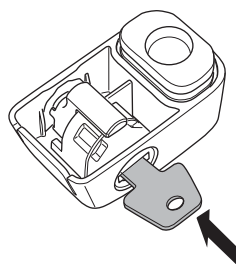

E

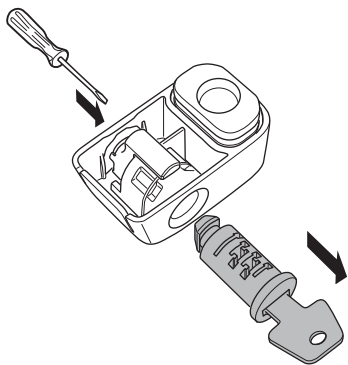

F

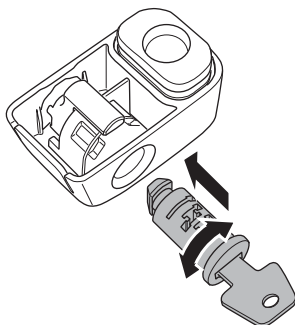

G

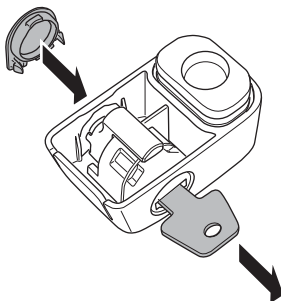

H

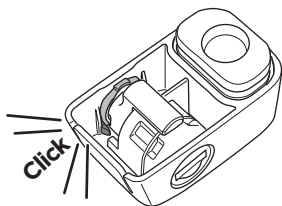

I

