

➤ Instructions

Thule Approach Annex 901019, 901020, 901021



➤ **Video Instructions**
Thule Approach Annex



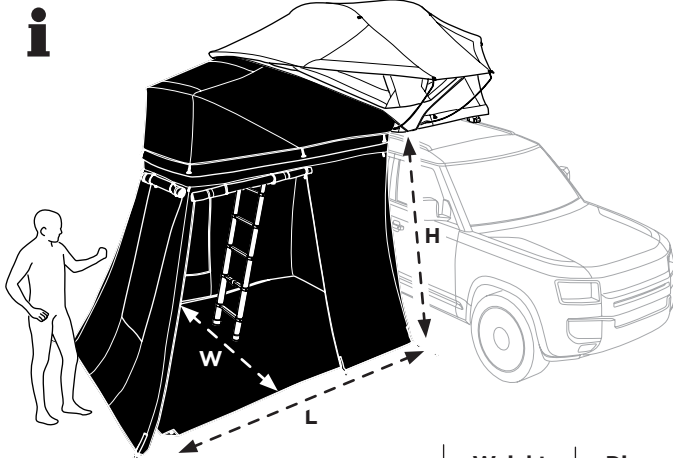
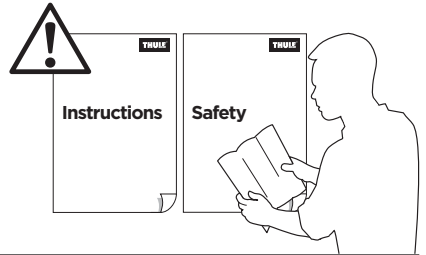
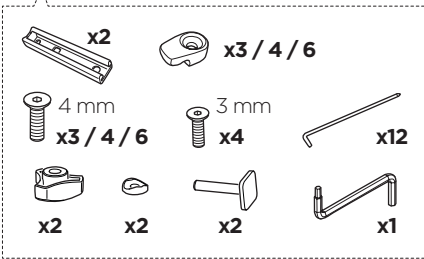
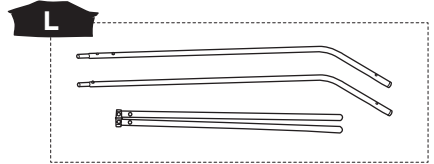
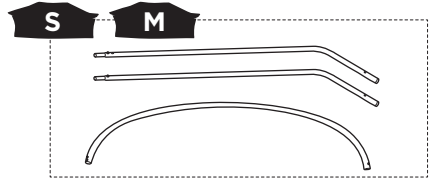
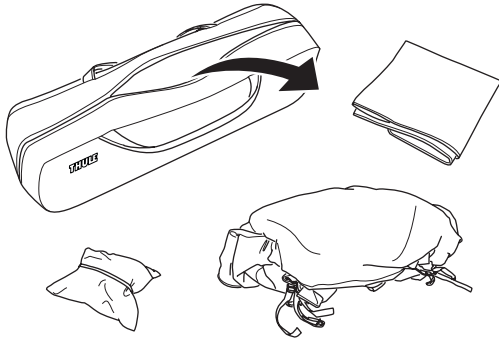

	Weight	Dimensions Floor L x W	Height
S Thule Approach Annex S 901019	6.2 kg 13.7 lbs	187 x 201 cm 74 x 79 in	165 - 215 cm 65 - 85 in
M Thule Approach Annex M 901020	7.3 kg 16.1 lbs	203 x 220 cm 80 x 87 in	165 - 215 cm 65 - 85 in
L Thule Approach Annex L 901021	7.7 kg 17 lbs	253 x 220 cm 99 x 87 in	165 - 215 cm 65 - 85 in

1

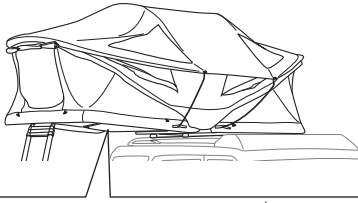

S



M



L

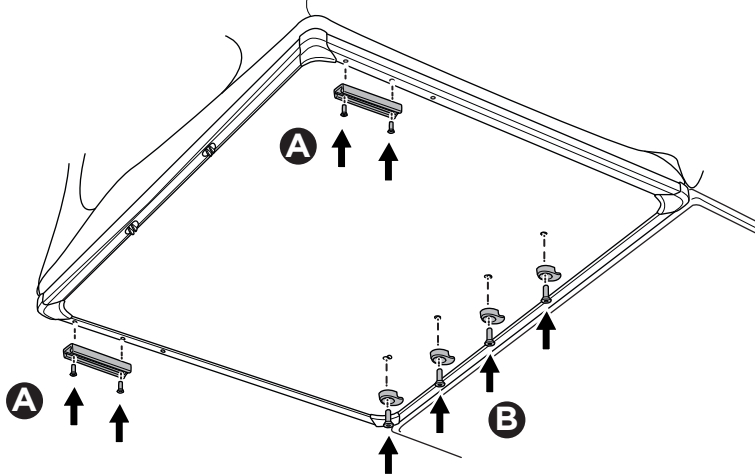
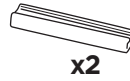

A

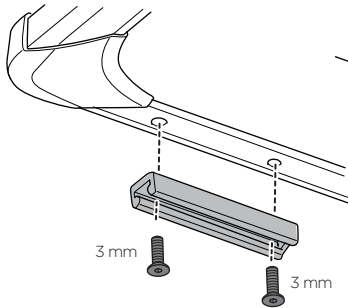

B

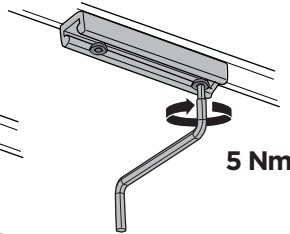

5 Nm

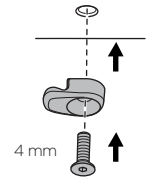

4 mm

5 Nm

i

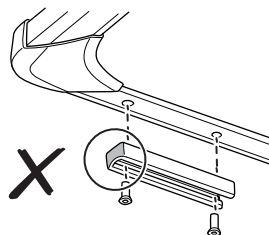
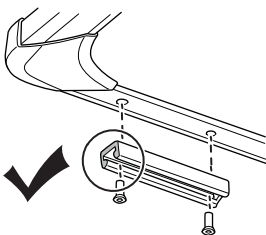

2

A

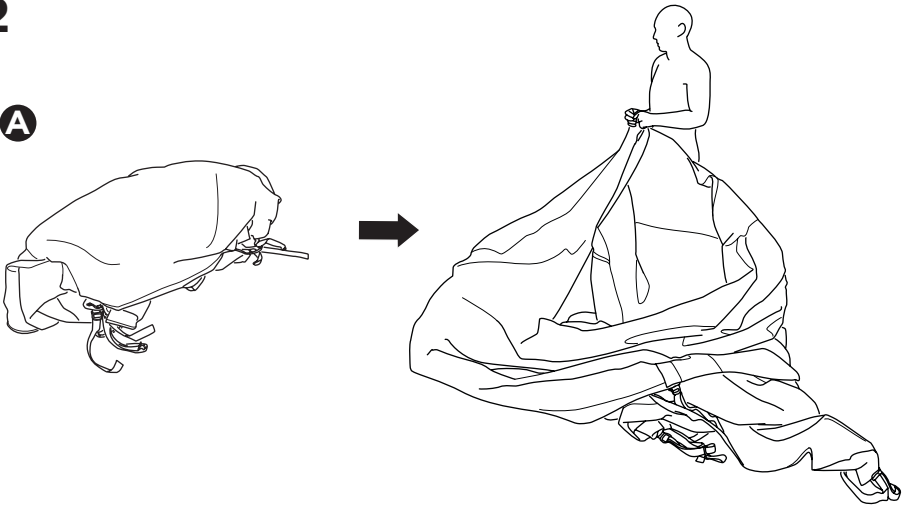

B

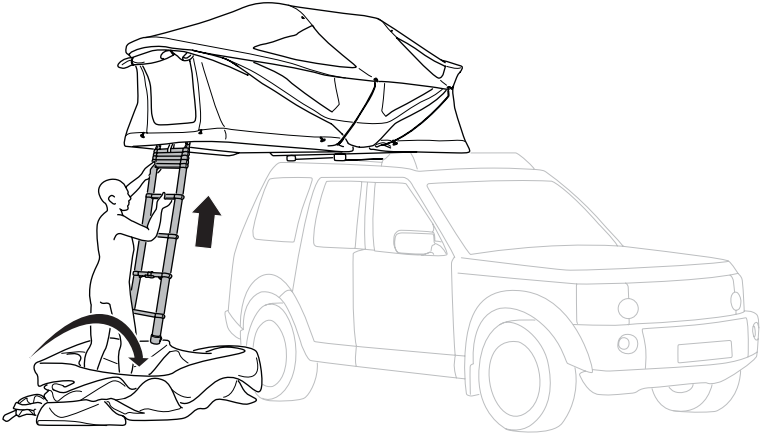

C



3

A

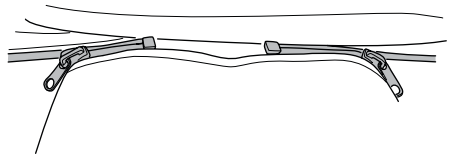
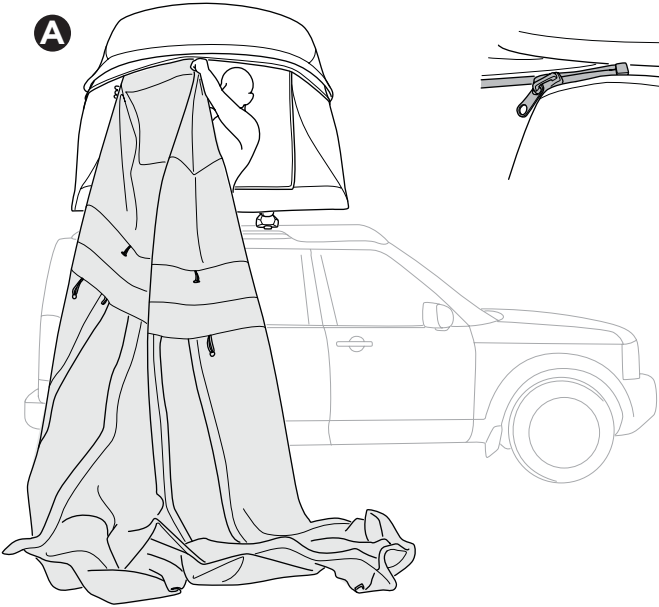

B

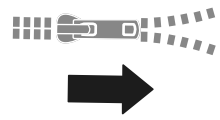
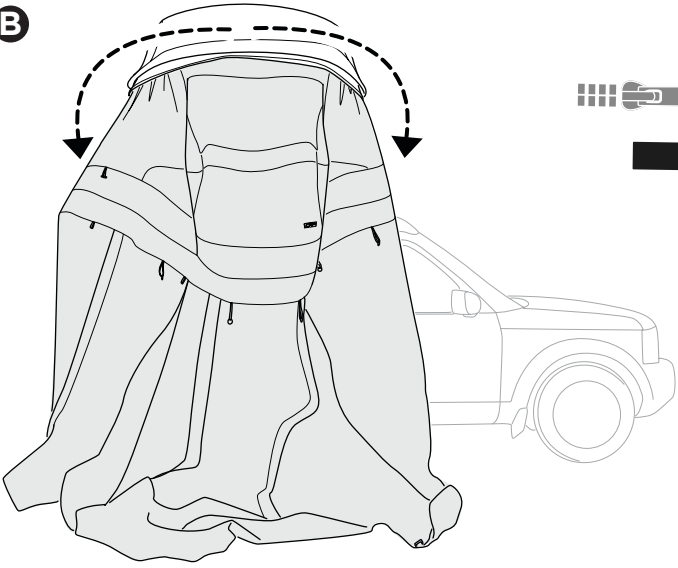

4

L

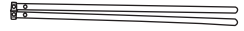

A

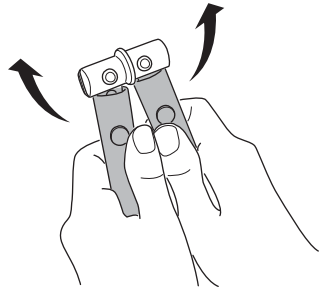
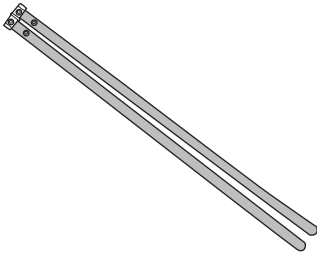

B

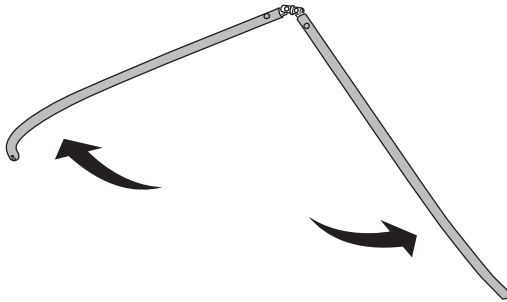

C

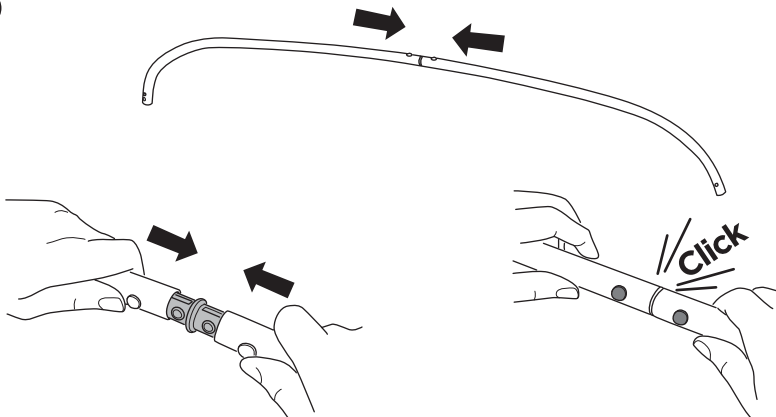

5

S M L

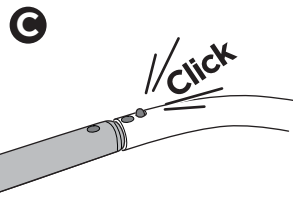
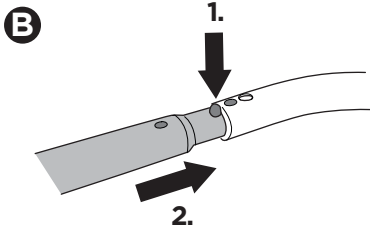
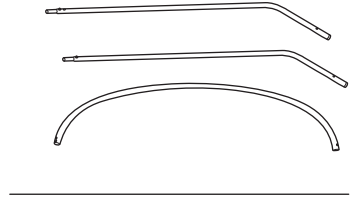
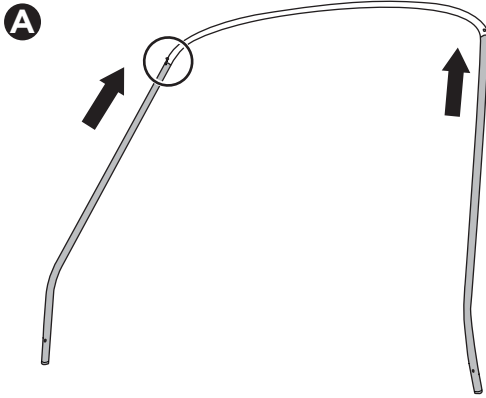

i

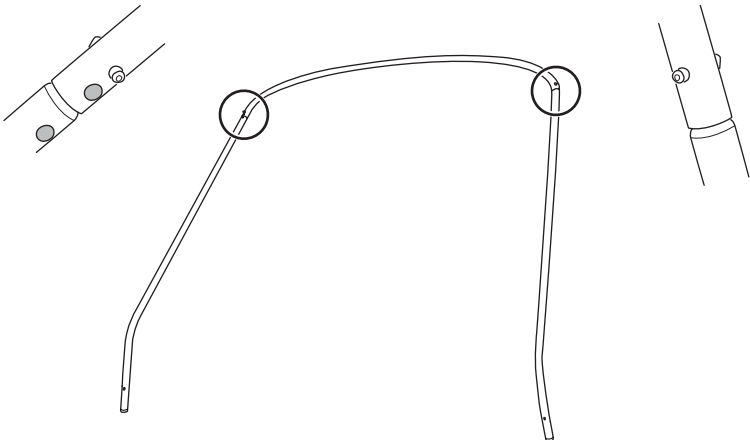

6

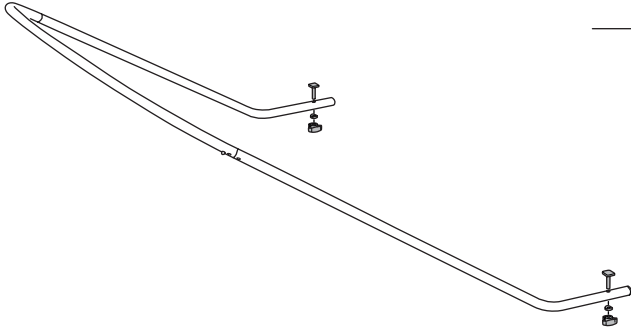

A

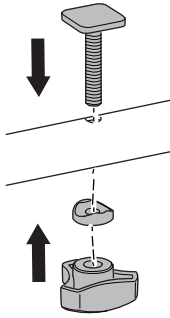

B

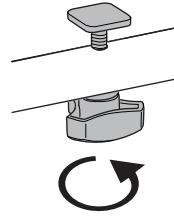

7

A



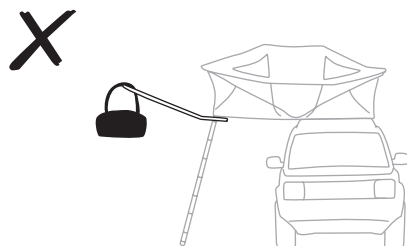
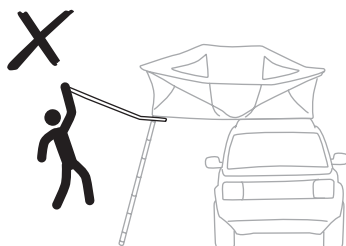
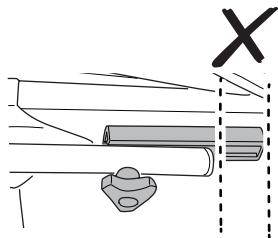
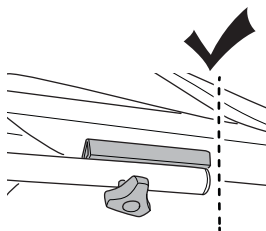
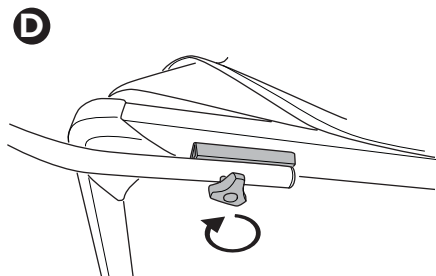
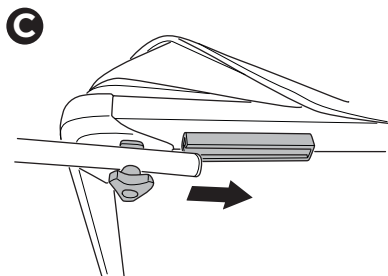
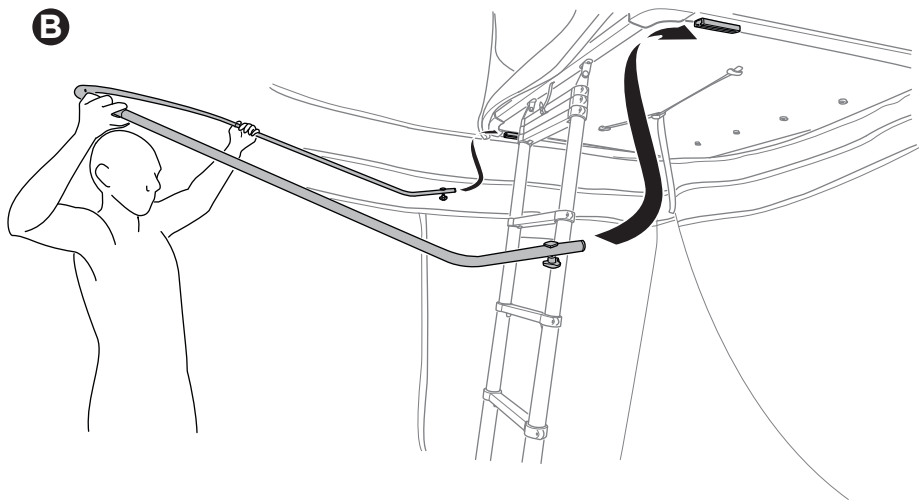

8

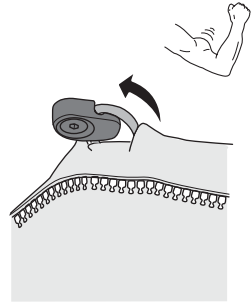
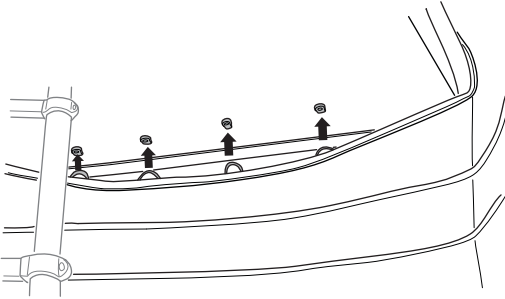
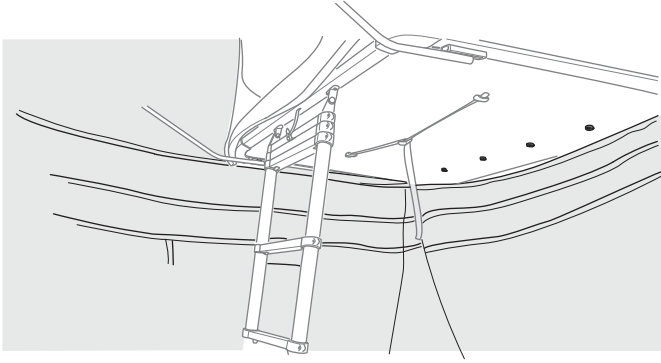

x4

i



Max 20 kg
44 lbs

i

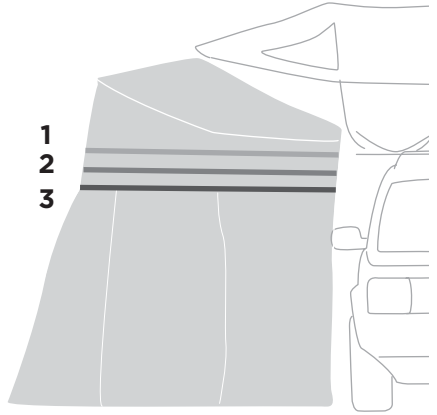
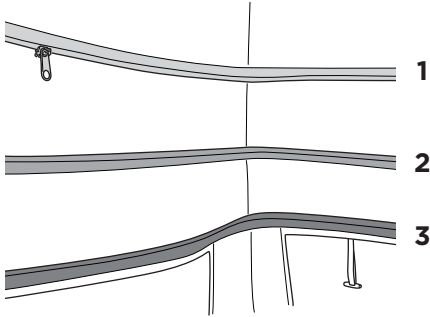
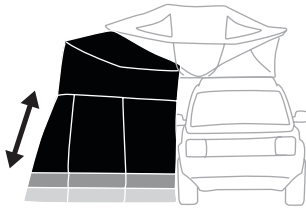

i

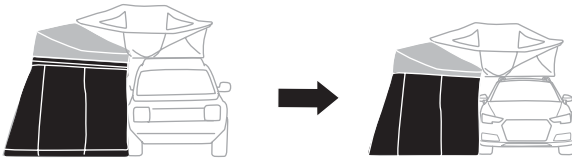

A

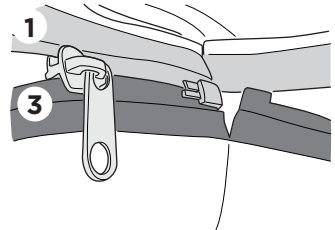
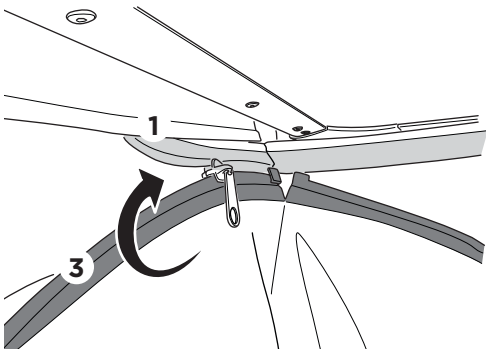

B

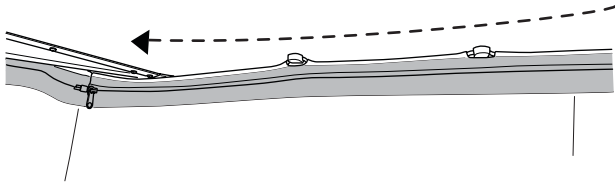
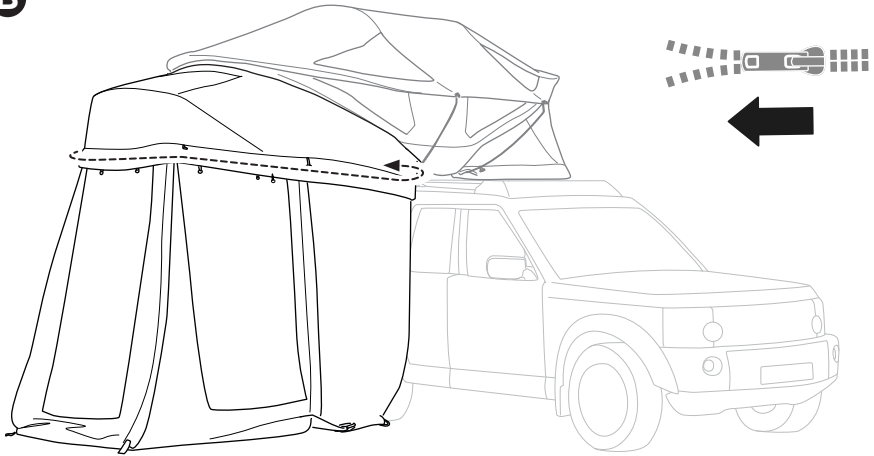

9

 x8



A

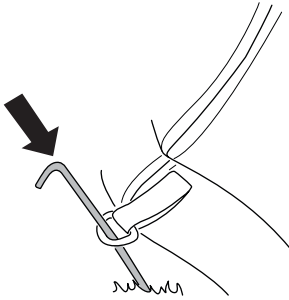

B

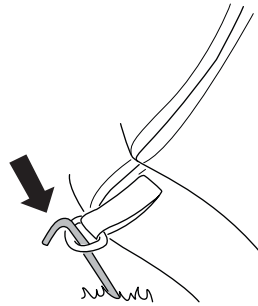

i

A



B

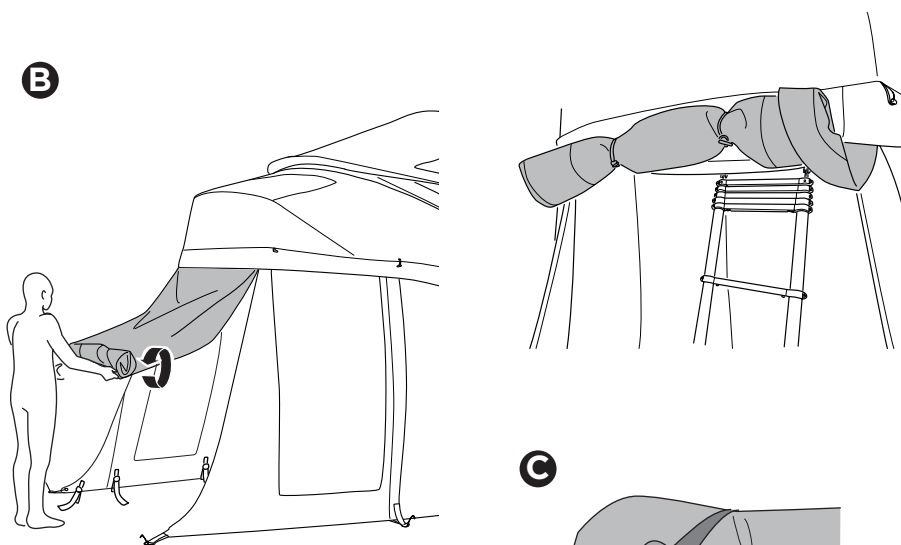

C

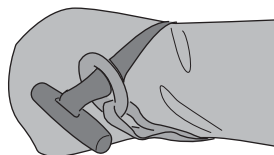

10

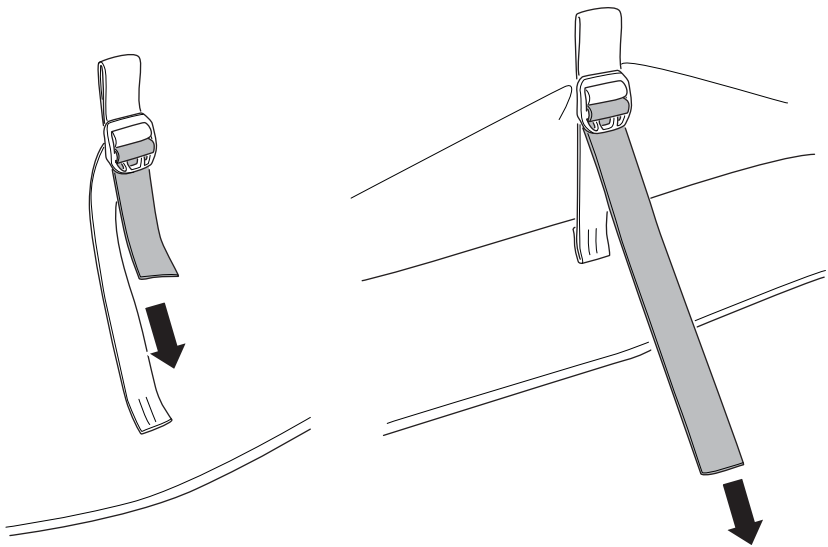

i

A



B

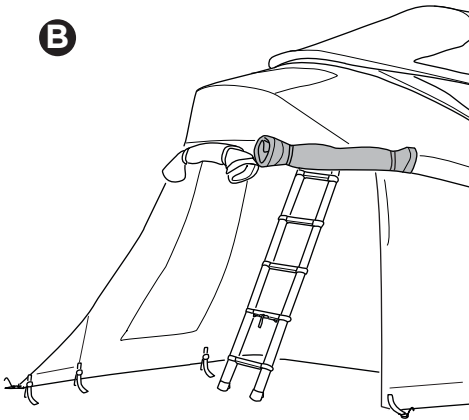

C

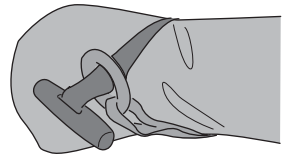

i

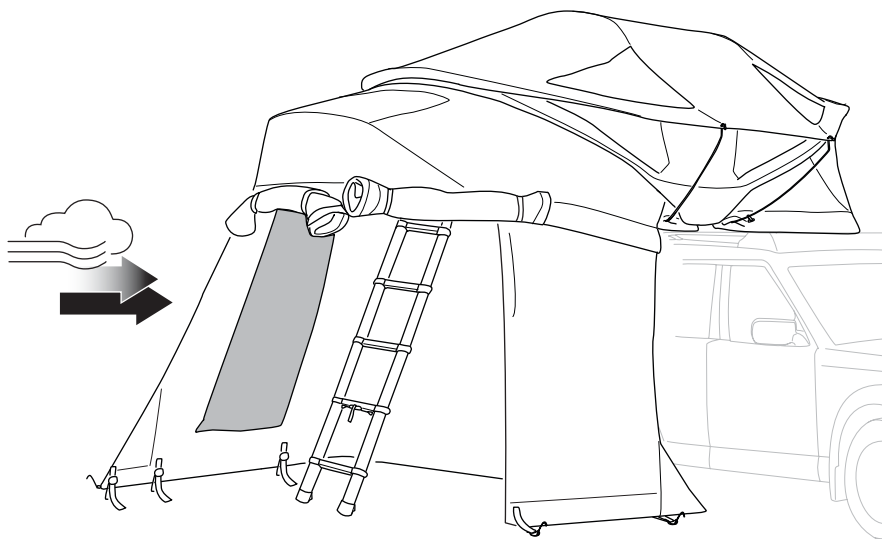

A

B

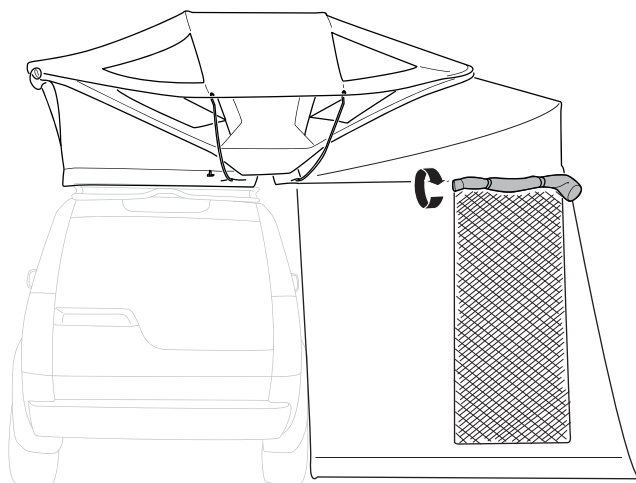

11

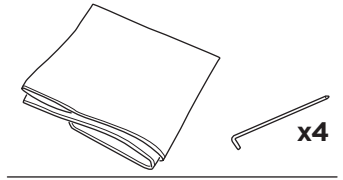

A

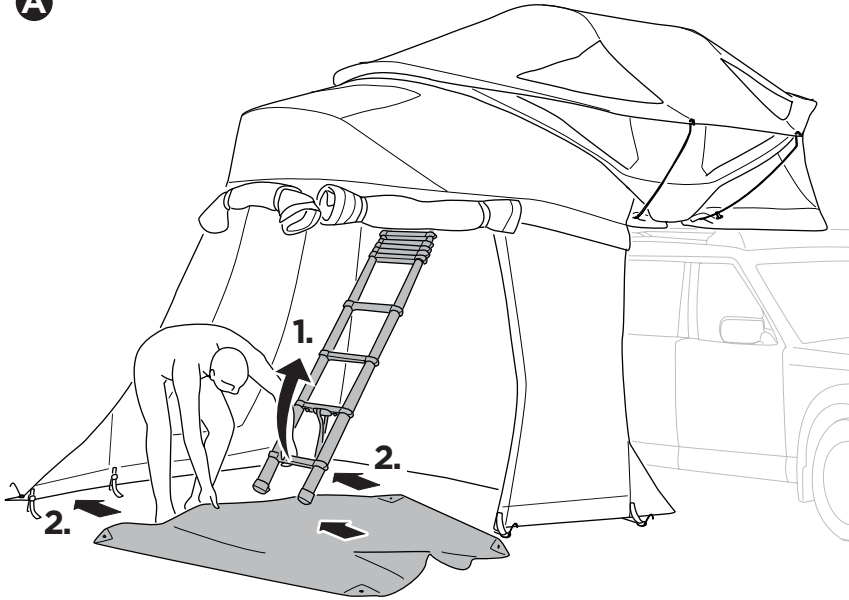

B

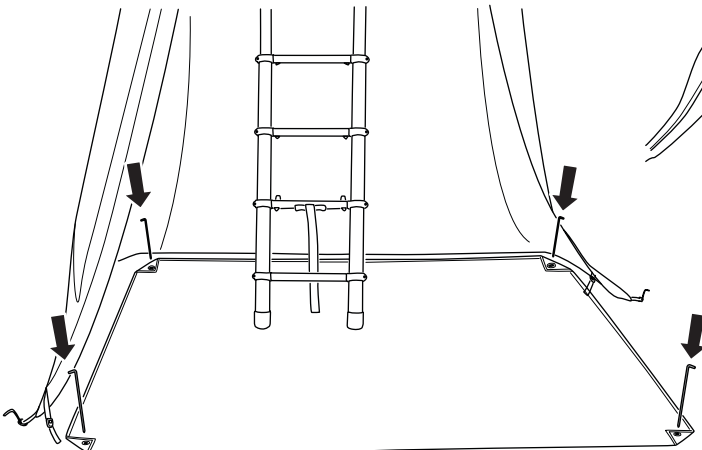

C

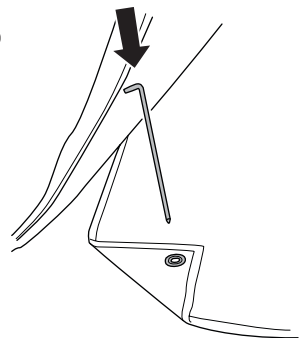

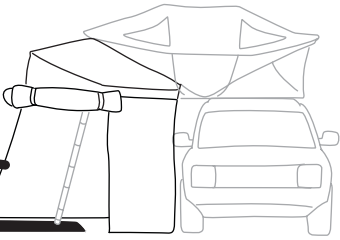
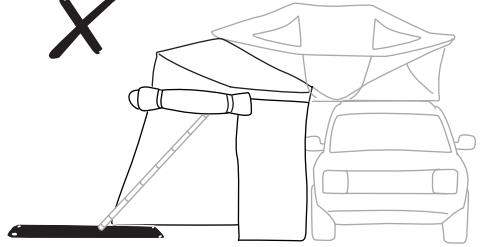
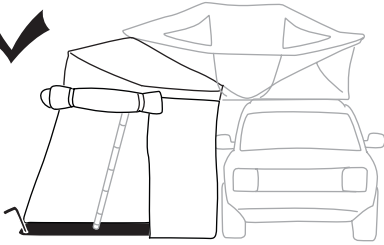

i

