

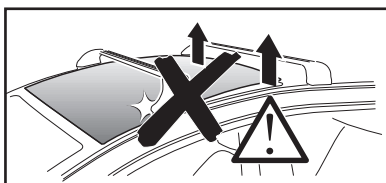

Thule XT Kit 3173

> Instructions

MERCEDES A-Class (W177), 5-dr Hatchback, 18-



This kit is only for vehicles with fixpoint mounting.

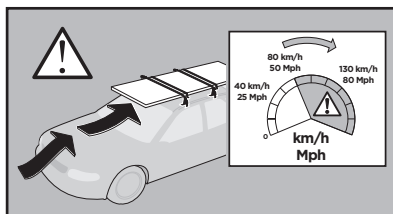
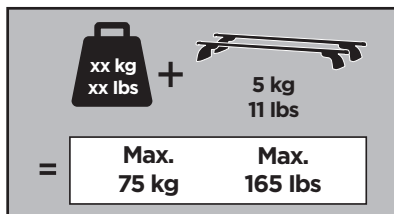
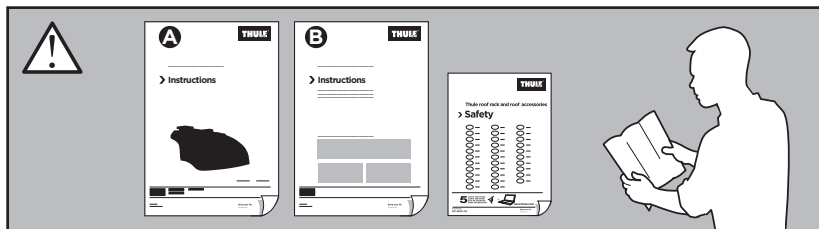

ISO 11154-E

183173

C.20180705
509-3173-01

Bring your life
thule.com

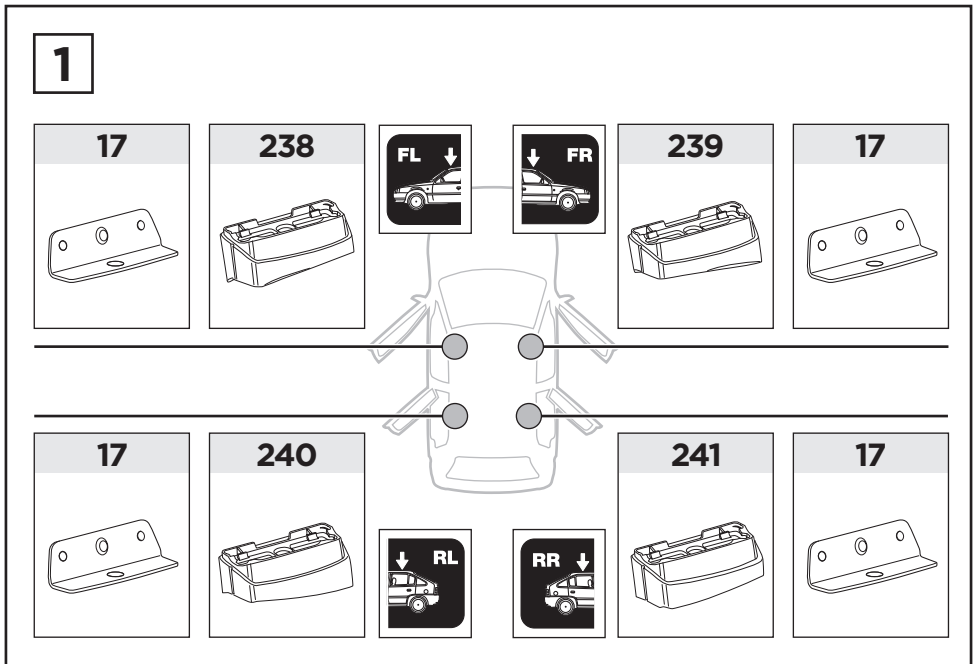
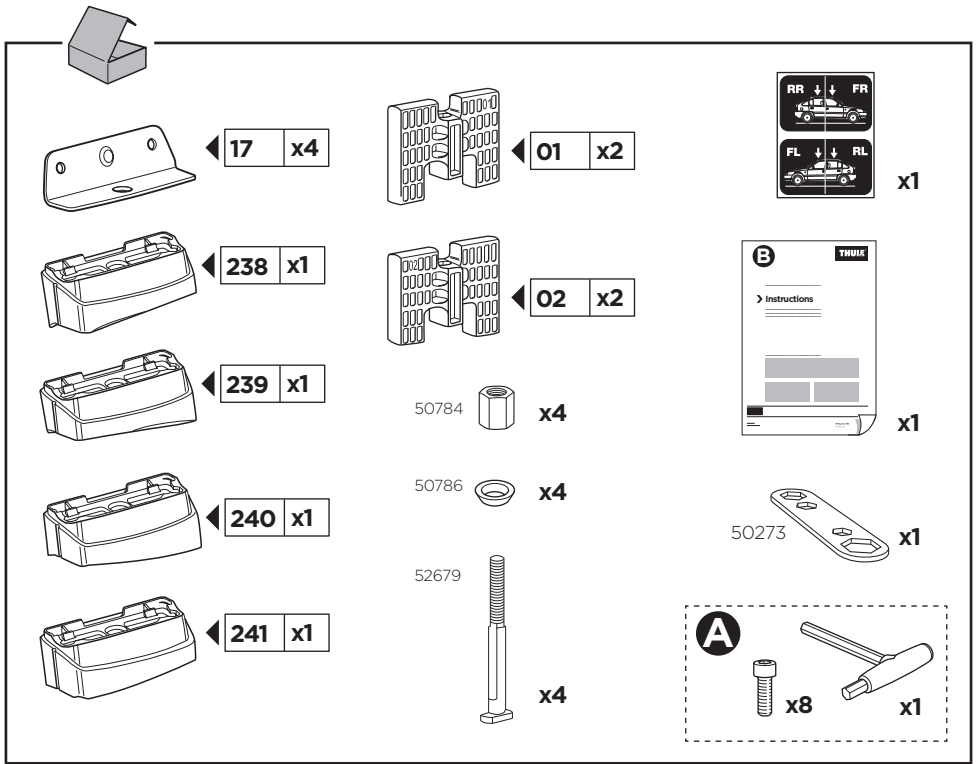

2 A

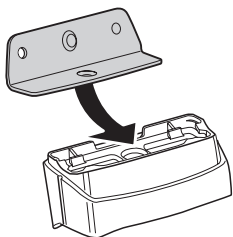

B

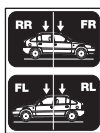

x1

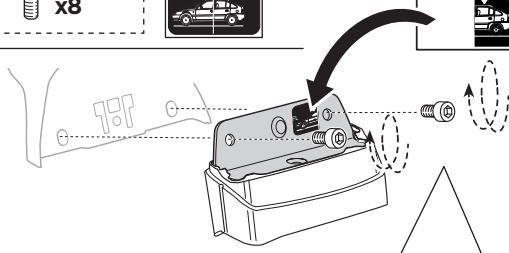
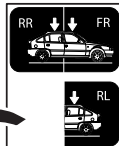

- EN** Only a few turns
- DE** Nur wenige Umdrehungen
- FR** Quelques tours uniquement
- NL** Slechts enkele slagen
- IT** Solo qualche giro
- ES** Sólo algunas vueltas
- PT** Apenas algumas voltas
- SV** Endast några varv
- DK** Kun nogle få omgange
- NO** Bare noen få omdreinger
- FI** Vain muutama kierros

- ET** Ainult mõni pööre
- LV** Tikai daži apgriezieni
- LT** Tik keli pasukimai
- PL** Wystarczy kilka obrotów
- RU** Только несколько оборотов
- UK** Лише декілька обертів
- BG** Само няколко завъртания
- CS** Pouze několik otáček
- SK** Len niekoľko otáčok
- SL** Le nekaj obratov
- HR/BIH** Samo nekoliko okreta

- RO** Doar câteva rotiri
- HU** Csak néhány fordítás
- EL** Μόνο λίγες περιστροφές
- TR** Yalnızca birkaç tur
- AR** بعض دورات فقط
- HE** רק מספר סיבובים
- ZH** 仅几圈
- JA** 2～3回転のみ
- KO** 몇 번만 돌리면 됨
- TH** □□□□□□□□□□□□

3



01 x2



02 x2

