



Thule XT Kit 3041

> Instructions

CITROËN C5, 4-dr Sedan, 01-07

This kit is only for vehicles with fixpoint mounting.

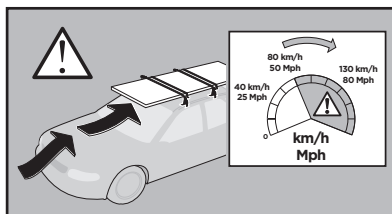
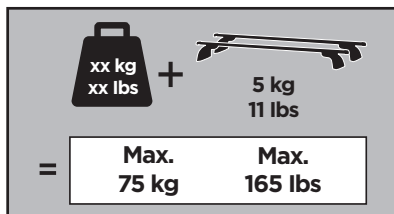
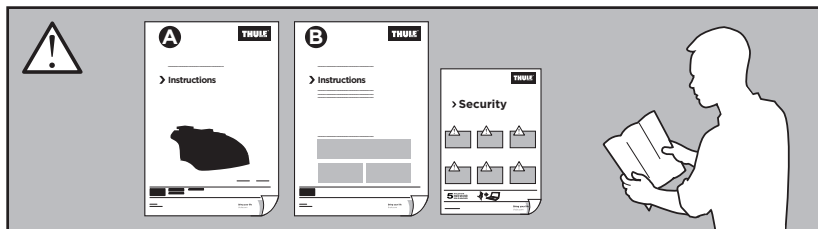

ISO 11154-E

183041

C.20130520
509-3041-04

Bring your life
thule.com

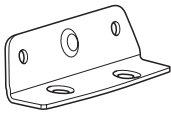

02 x2

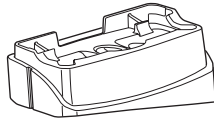

29 x2

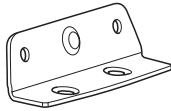
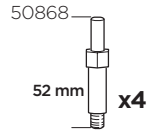

03 x2

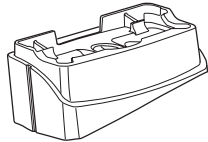

30 x2

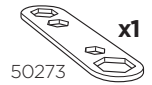
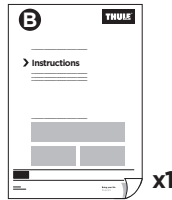
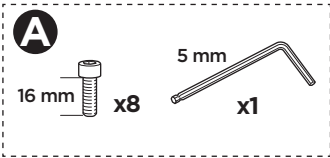
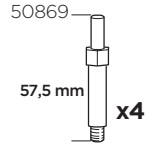

1

03



30

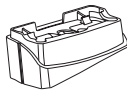

FL ↓



↓ FR



29

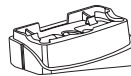

02

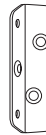

02



29



↓ RL



RR ↓



30



03

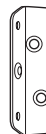

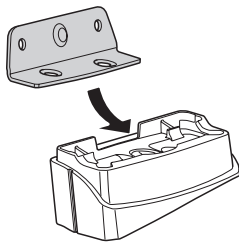
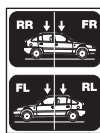
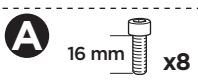
2 A**B**

x1

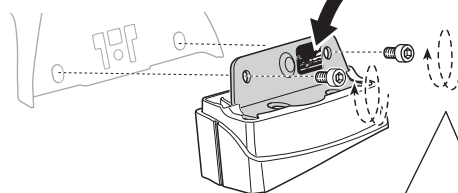
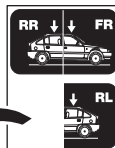
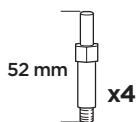
**EN** Only a few turns**DE** Nur wenige Umdrehungen**FR** Quelques tours uniquement**NL** Slechts enkele slagen**IT** Solo qualche giro**ES** Sólo algunas vueltas**PT** Noções básicas**SV** Endast några varv**DK** Kun nogle få omgange**NE** Bare noen få omdreinger**FI** Vain muutama kierros**ET** Ainult mõni pööre**LV** Tikai dažī apgriezieni**LT** Tik keli pasukimai**PL** Wystarczy kilka obrotów**RU** Только несколько оборотов**UK** Лише декілька обертів**BG** Само няколко завъртания**CS** Pouze několik otáček**SK** Len niekoľko otáčok**SL** Le nekaj obratov**HR/BiH** Samo nekoliko okreta**RO** Doar câteva rotiri**HU** Csak néhány fordítás**EL** Μόνο λίγες περιστροφές**TR** Yalnızca birkaç tur**AR** بعض دورات فقط**HE** רק מספר סיבובים**ZH** 仅几圈**JA** 2～3回転のみ**KO** 몇 번만 돌리면 됨**TH** เพียงสองสามรอบ**3**

x4

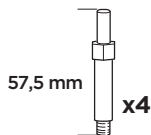

x4

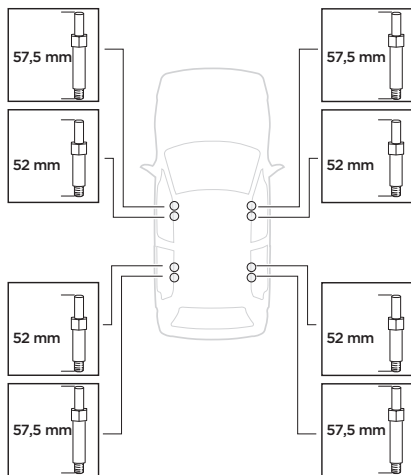
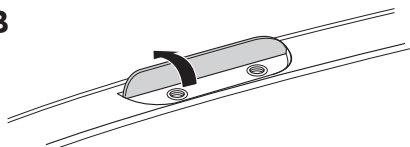
A**B****C**