



## Thule XT Kit 3014

# > Instructions

NISSAN Primera (W12), 5-dr Estate, 02-07

This kit is only for vehicles with fixpoint mounting.

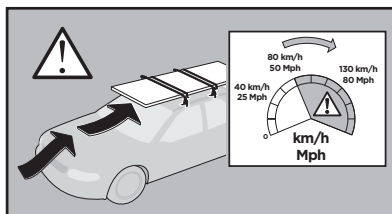
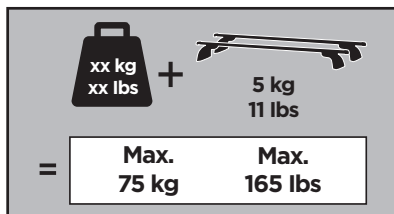
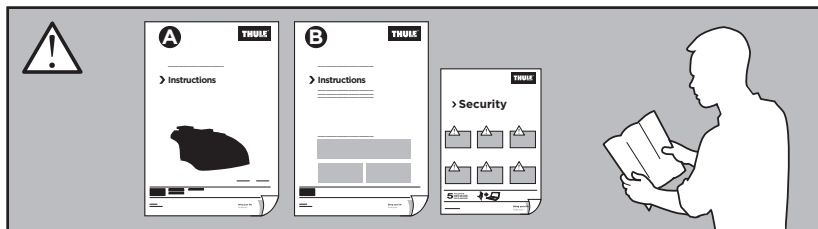

ISO 11154-E

183014

C.20130604  
509-3014-02

Bring your life  
thule.com

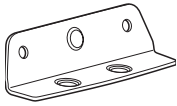

◀ 05 x4

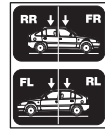
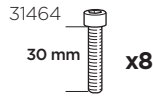

x1

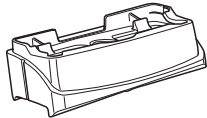

◀ 18 x2

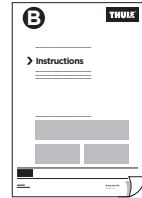

x1

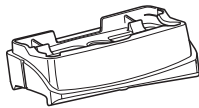

◀ 19 x2

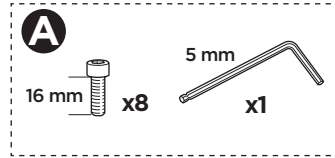

1

05

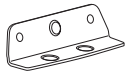

18

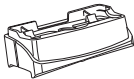

FL ↓



↓ FR



19

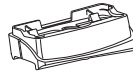

05

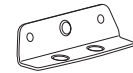

05

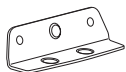

19

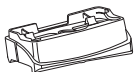

↓ RL



RR ↓



18



05

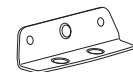

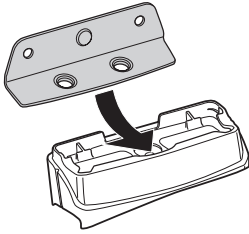
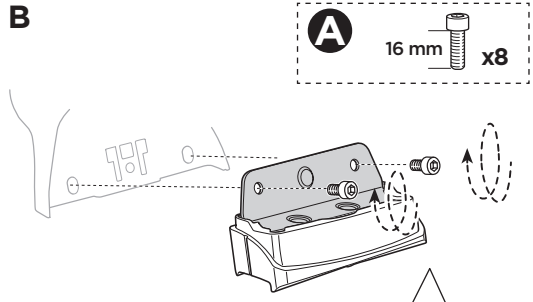
**2****A****B**

**EN** Only a few turns  
**DE** Nur wenige Umdrehungen  
**FR** Quelques tours uniquement  
**NL** Slechts enkele slagen  
**IT** Solo qualche giro  
**ES** Sólo algunas vueltas  
**PT** Noções básicas  
**SV** Endast några varv  
**DK** Kun nogle få omgange  
**NE** Bare noen få omdreinger  
**FI** Vain muutama kierros  
**ET** Ainult mõni pööre  
**LV** Tikai dažī apgriezieni  
**LT** Tik keli pasukimai  
**PL** Wystarczy kilka obrotów  
**RU** Только несколько оборотов

**UK** Лише декілька обертів  
**BG** Само няколко завъртания  
**CS** Pouze několik otáček  
**SK** Len niekoľko otáčok  
**SL** Le nekaj obratov  
**HR/BIH** Samo nekoliko okreta  
**RO** Doar câteva rotiri  
**HU** Csak néhány fordítás  
**EL** Μόνο λίγες περιστροφές  
**TR** Yalnızca birkaç tur

بعض دورات فقط

**AR**

רק מספר סיבובים

**HE**

**ZH** 仅几圈  
**JA** 2～3回転のみ  
**KO** 몇 번만 돌리면 됨  
**TH** เพียงสองสามรอบ

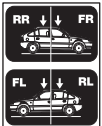
**3**

x1

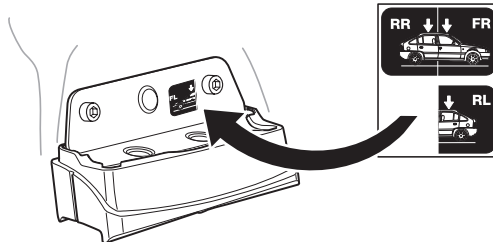

4

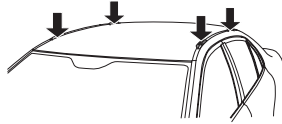

A

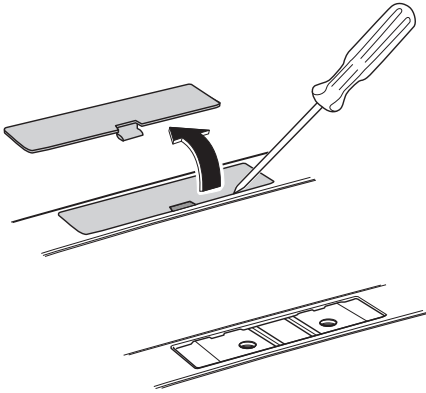

B

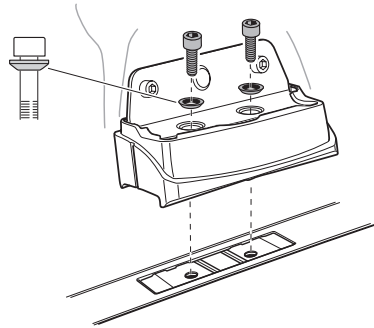

5

A



B

6 Nm

